

Once the magnetic sensor has been properly connected to the terminal block, connect the terminal block to the vehicle's battery using the black and red cables provided.

The RED wire with the in-line fuse (+12VDC) should be connected to the POSITIVE terminal on the battery and to the same location on the terminal block as the red wire from the magnetic sensor. The BLACK wire (Ground) should be connected to the NEGATIVE terminal on the battery and to the same location on the terminal block as the black wire from the magnetic sensor.

Finally, connect the DMI Connector Cable (K) to the terminal block as follows:

- Connect the black wire to the battery ground and sensor black wire.
- Connect the yellow wire to the battery +12 VDC and sensor white wire.
- Connect the green wire to sensor red wire.

The red wire from the DMI connector cable is not used.

Once these steps are complete, you may connect the DMI itself.

Troubleshooting

The most common reason a DMI won't count is because the calibration factor has been accidentally cleared from the DMI memory. If you are using the JAMAR RAC DMI, the calibration factor is displayed for 4 to 5 seconds every time the instrument is turned on. Make sure the factor is not showing all zeros (0.000). If you are using a different brand of DMI, make sure it does have a calibration number in its memory.

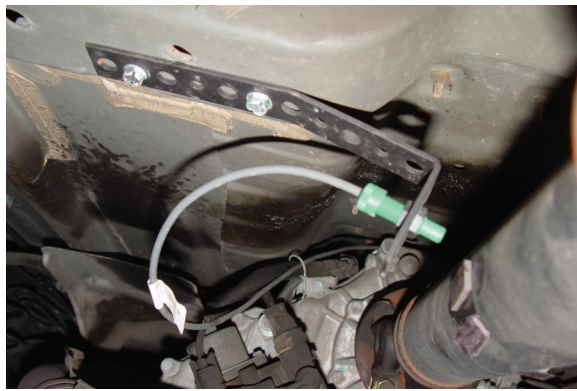

Figure 9 – Typical Drive Shaft Installation

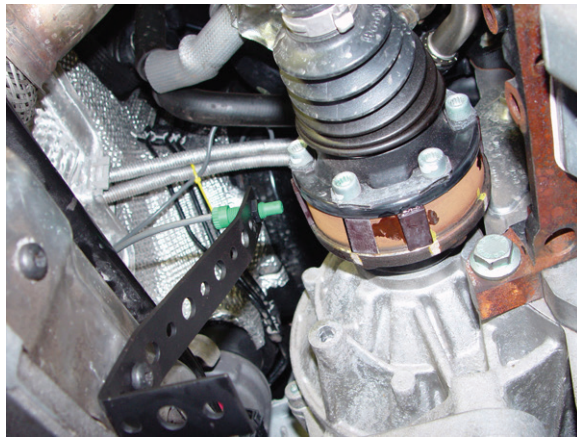

Figure 10 – Typical Front Wheel Drive Installation

Installing the Magnetic Sensor

For vehicles that are not compatible with the standard Modular Distance Sensor, the Magnetic Sensor should be used in its place. *Note that if you are installing the Magnetic Sensor you do not need the Modular Sensor as part of the installation.*

For the installation you will need the Magnetic Sensor Kit shown in Figure 1 below,

- A – Magnets
- B – Epoxy
- C – Zip Ties
- D – Mounting Bracket
- E – Hardware Kit
- F – Magnetic Sensor
- G – Extension Cable

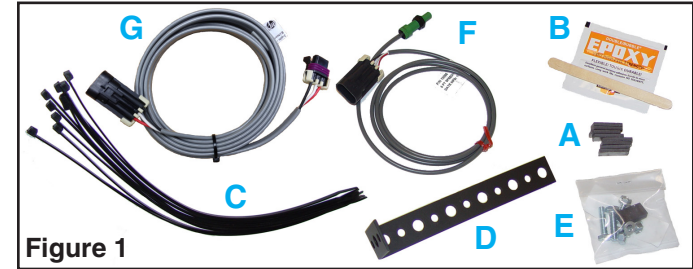

Figure 1

and the Vehicle Installation Kit shown in Figure 2.

- H – Terminal Block
- I – Power Cable
- J – Ground Cable
- K – DMI Connector Cable
- L – Velcro
- M – Zip Ties

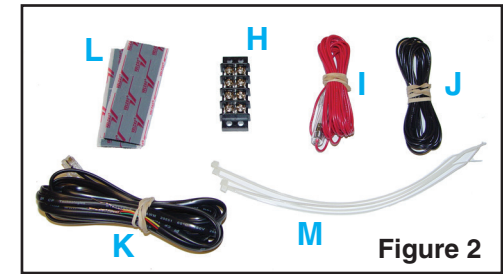
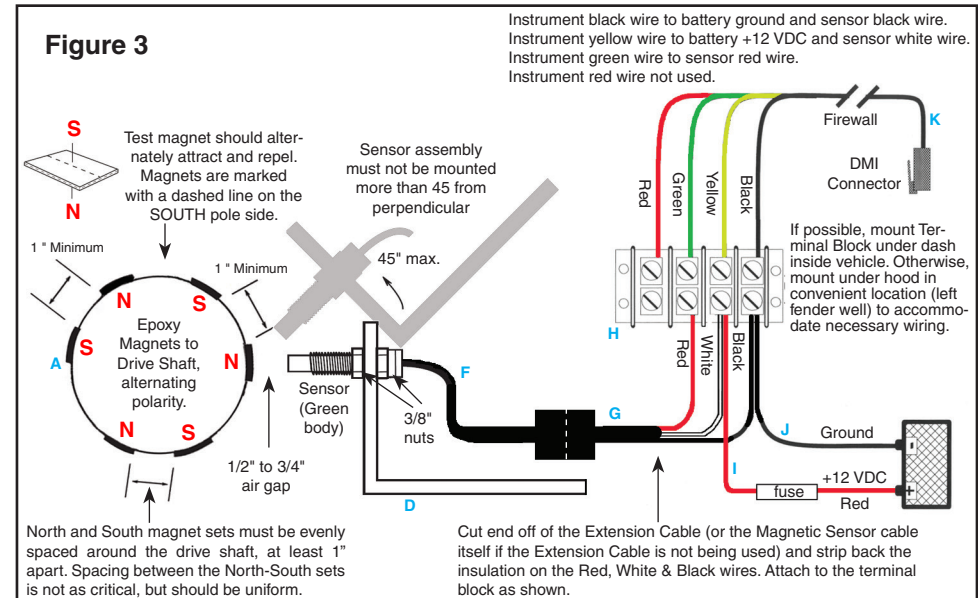

Figure 2

Once you have finished the following steps, your installation should look similar to Figure 3 below.



Step 1 - Installing the Magnets

The number of magnets that must be used depends on the size of your tire and where you mount the sensor. Most all installations on automobiles or trucks will require at least six magnets (3 North/South Sets) to be installed. This will provide 3 pulses per revolution of the wheel or drive shaft to be sent to the Distance Measuring Instrument (DMI).

On tractor or implement wheels the general rule of thumb is one magnet for each wheel bolt (minimum of two, and always an even number). For drive shafts of small wheels (ATVs), two magnets are usually adequate.

The magnets provided are marked with a dashed line on the SOUTH pole side of the magnet, as shown in Figure 4.

Always use an even number of magnets, and always alternate the polarities of the magnets as you go around the wheel hub or drive shaft.

To install the magnets (part A in figure 1) on the drive shaft, use the Epoxy (B). Spare magnets are provided in the Hardware Kit (E) should they be needed.

(For **front wheel drive** vehicles, the magnetic targets should be attached to the inner CV joint, on the larger section between the rubber boot and the transmission.)

Note that the epoxy provided needs 6-8 hours to cure properly before the vehicle should be driven. The magnets can come loose and be lost if the vehicle is driven before the epoxy has a chance to cure. A quicker setting epoxy can be used if you need to cut down on curing time. Also, the zip ties (C) can be used to tie the magnets in place after the epoxy dries to make sure they stay in place.

Mount the first magnet with the SOUTH pole side (dashed line) facing toward the hub or shaft. Mount the second magnet with the NORTH pole side facing toward the hub or shaft, as shown in Figure 5. A test magnet should be used after installation to ensure the magnets have been placed correctly. Pass the test magnet over the installed magnets and it should alternately attract and repel.

For proper operation, the North and South magnet sets must be evenly spaced around the wheel or drive shaft, at least 1" apart, as shown in Figure 6. Spacing from one North-South magnet set to the next set is not as critical, but should be uniform.

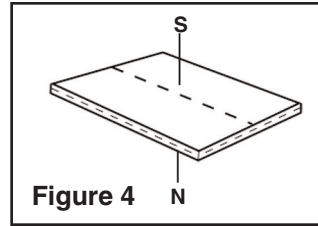

Figure 4

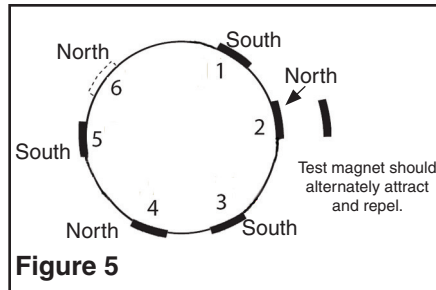

Figure 5

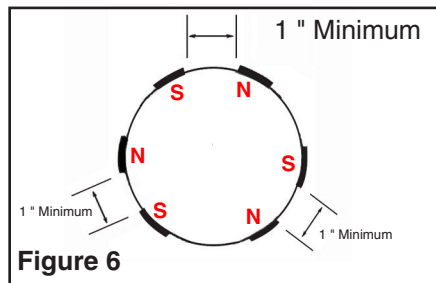

Figure 6

Step 2 – Attaching the Magnetic Sensor

The Magnetic Sensor (F) is mounted directly over the magnets as shown in figure 3. When the wheel or drive shaft begins turning, a speed impulse is sent to the DMI every time a magnet passes by the tip of the speed sensor. For the speed sensor to operate properly, the spacing between the magnets and the tip of the sensor must always remain constant. Before permanently mounting any parts, be sure that the location you have selected will meet the requirements shown in Figure 7. NOTE: Observe magnet polarities (see previous section).

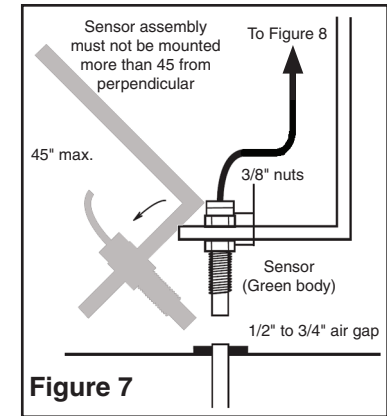

Figure 7

Using the Sensor Bracket (D) provided, locate a nut or bolt on the side of the transmission, close to the magnets. Attach the bracket to the transmission using the hardware. (You may have to drill a larger hole in the sensor bracket to allow proper fitting over the selected bolt/stud.) Bend the bracket as required so that the Sensor is scanning the targets with a spacing of about 1/2 to 3/4 inch. The cable coming from the Magnetic Sensor will be used as part of the next step.

Step 3 - Installing and Wiring the Terminal Block

Mount the Terminal Block (H) provided with the Vehicle Installation Kit under the dash inside the vehicle, if possible. If it is not possible to mount it inside the vehicle, mount on the driver's side fender well or other convenient location. The terminal block can be mounted using the Velcro provided.

The Magnetic Sensor cable has 5 feet of a jacketed 3 wire cable with a water tight plug on the end. There is also a heavier wire Extension Cable (G) 10 feet in length. This will allow you to use up to 15 feet of wire for the installation from the magnetic sensor location to the terminal block. Depending on where you have attached the magnetic sensor (Front Wheel CV Joint or Rear Wheel Drive Shaft) and the location of the terminal block, you may or may not need the extension cable.

If the extension cable is needed, plug the extension cable into the magnetic sensor cable using the water tight connector, then cut the extension cable to the required length, strip back the insulation on the Red, White & Black wires and attach to the terminal block as shown in Figure 8. Each wire should be connected to a separate terminal on the block.

If the extension cable is not needed, cut the plug off the end of the smaller magnetic sensor cable, strip the wires and attach to the terminal block as shown in Figure 8.

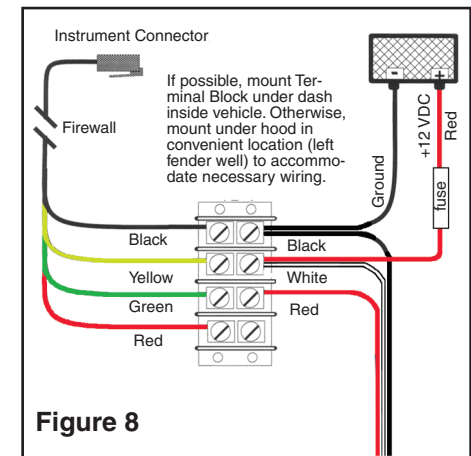

Figure 8

Instrument black wire to battery ground and sensor black wire.
Instrument yellow wire to battery +12 VDC and sensor white wire.
Instrument green wire to sensor red wire.
Instrument red wire not used.